

EMPIRE
2100/5034/2503
2501/5034/2300

- | | | | |
|-----------|--|-----------|---|
| D | MONTAGEANLEITUNG
BEDIENUNGSANLEITUNG | GB | ASSEMBLY INSTRUCTIONS
INSTRUCTION MANUAL |
| NL | HANDLEIDING VOOR DE MONTAGE
GEBRUIKSAANWIJZING | PL | INSTRUKCJA MONTAŻU
INSTRUKCJA OBSŁUGI |
| TR | MONTAJ TALIMATI
KULLANIM KLAVUZU | RU | ИНСТРУКЦИЯ ПО МОНТАЖУ
ИНСТРУКЦИЯ ПО ЭКСПЛУАТАЦИИ |
| RO | INSTRUCȚIUNI DE INSTALARE
INSTRUCȚIUNI DE UTILIZARE | IT | ISTRUZIONI DI MONTAGGIO
MANUALE DI ISTRUZIONI |
| FR | NOTICE DE MONTAGE
MANUEL INSTRUCTIONS | SK | MONTÁŽNY NÁVOD
NÁVOD NA POUŽITIE |
| HU | KÖZGYŰLÉS UTASÍTÁSOK
KEZELÉSI UTASÍTÁS | CZ | MONTÁŽNÍ NÁVOD
NÁVOD K POUŽITÍ |
| SI | NAVODILA ZA MONTAŽO
NAVODILA ZA UPORABO | PT | INSTRUÇÕES DE MONTAGEM
MANUAL DO USUÁRIO |
| ES | INSTRUCCIONES DE MONTAJE
MANUAL DEL USUARIO | HR | UPUTE ZA MONTAŽU
UPUTE ZA UPOTREBU |

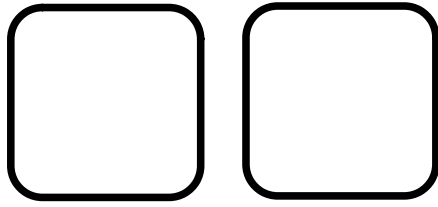

190801



0064

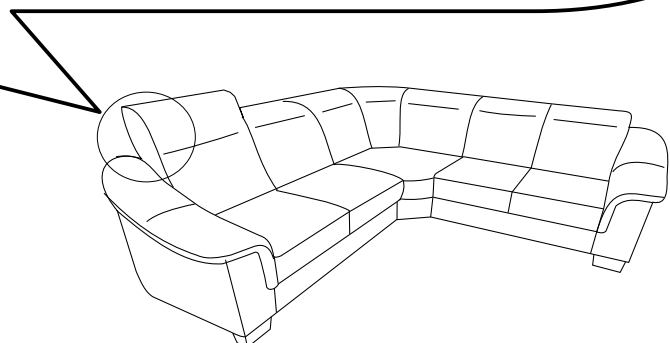
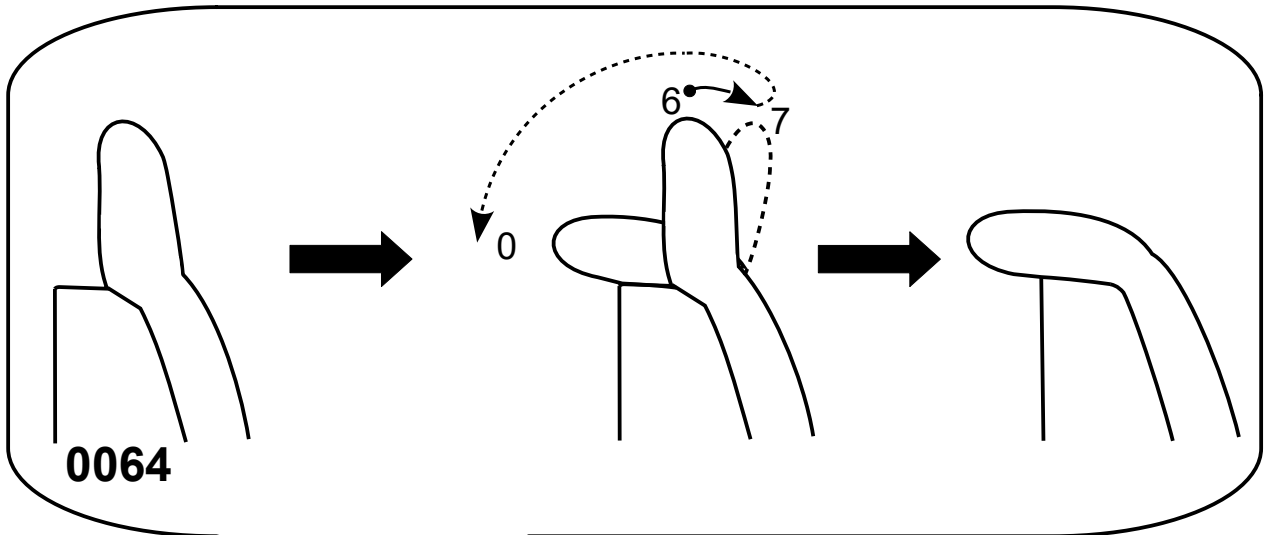
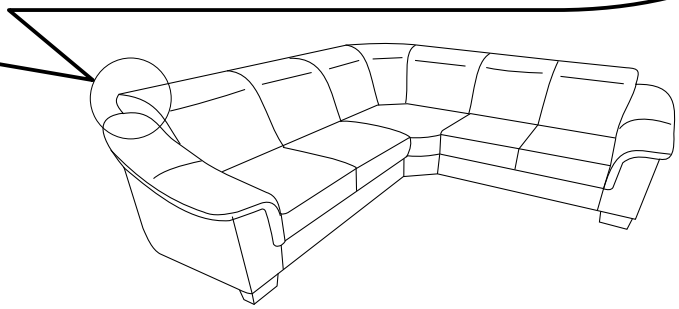
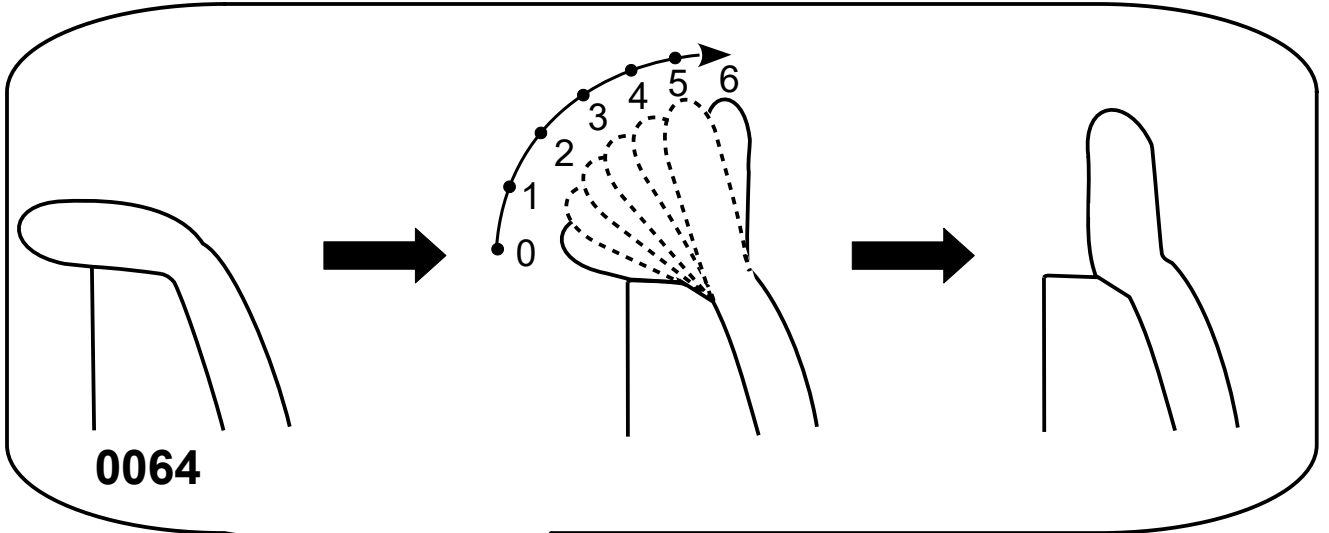

R

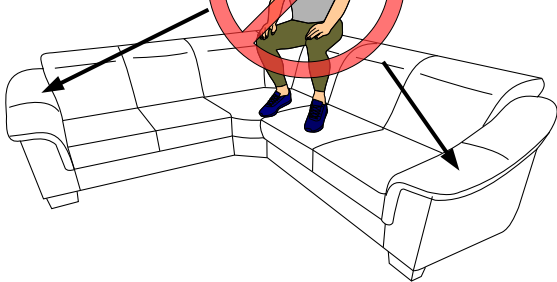

L

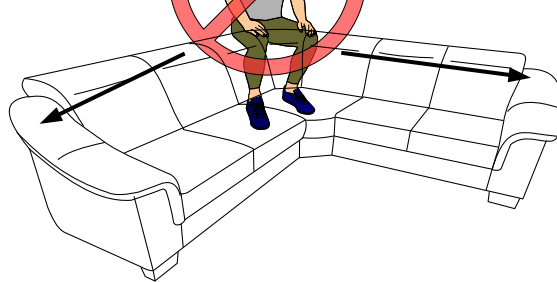





i L-5 X1	d M8*80 X4	f H-90 X4	x Fi-50 X4	g H(70-120) [mm] X2
------------------------	--------------------------	-------------------------	--------------------------	-----------------------------------

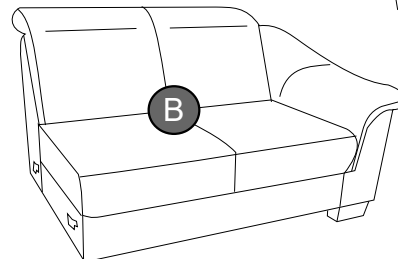
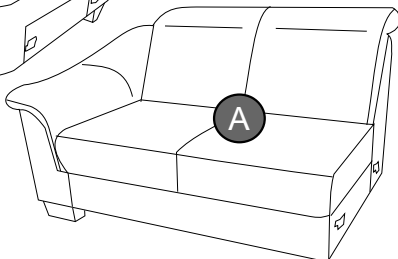
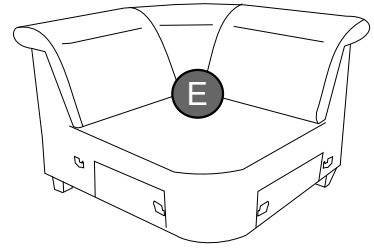
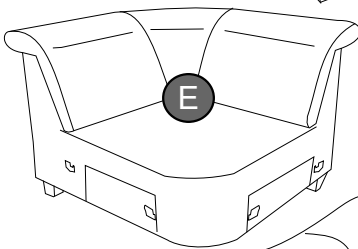
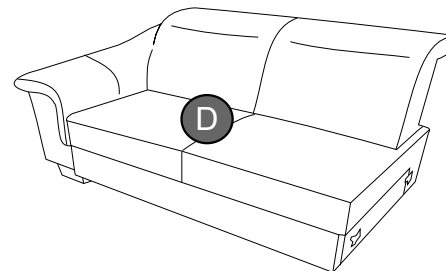
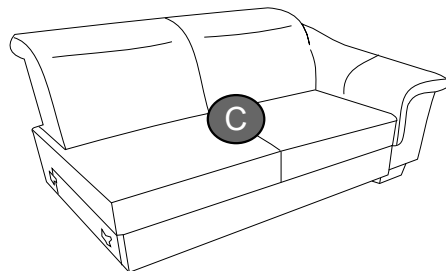
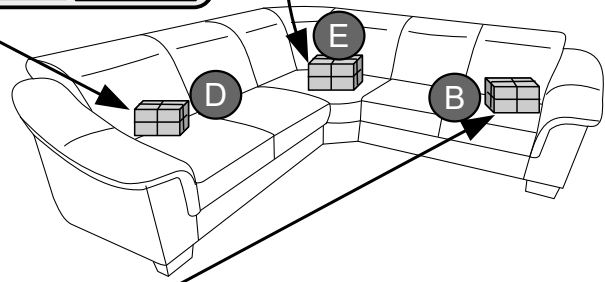
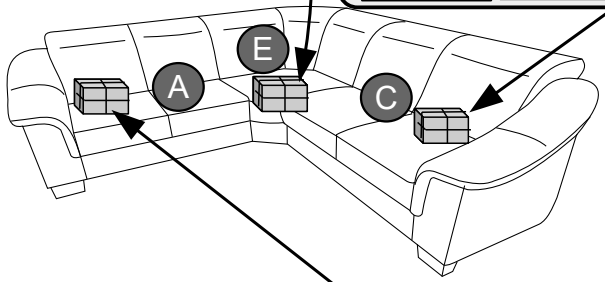



s H-90 X1	f H-90 X1	x Fi-50 X3	q M8*80 X3	i L-5 X1
-------------------------	-------------------------	--------------------------	--------------------------	------------------------

i L-5 X1	s H-90 X1	f H-90 X1	x Fi-50 X3	q M8*80 X3
------------------------	-------------------------	-------------------------	--------------------------	--------------------------

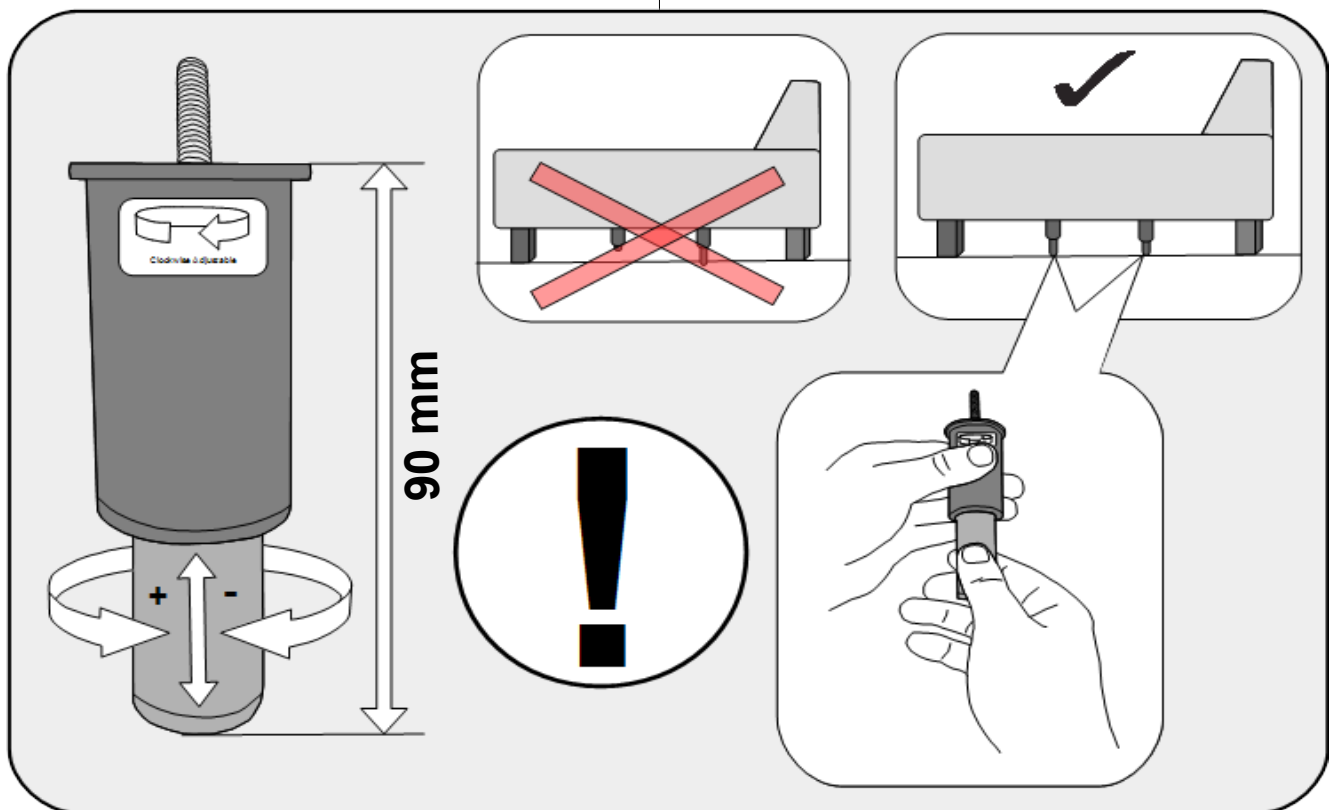
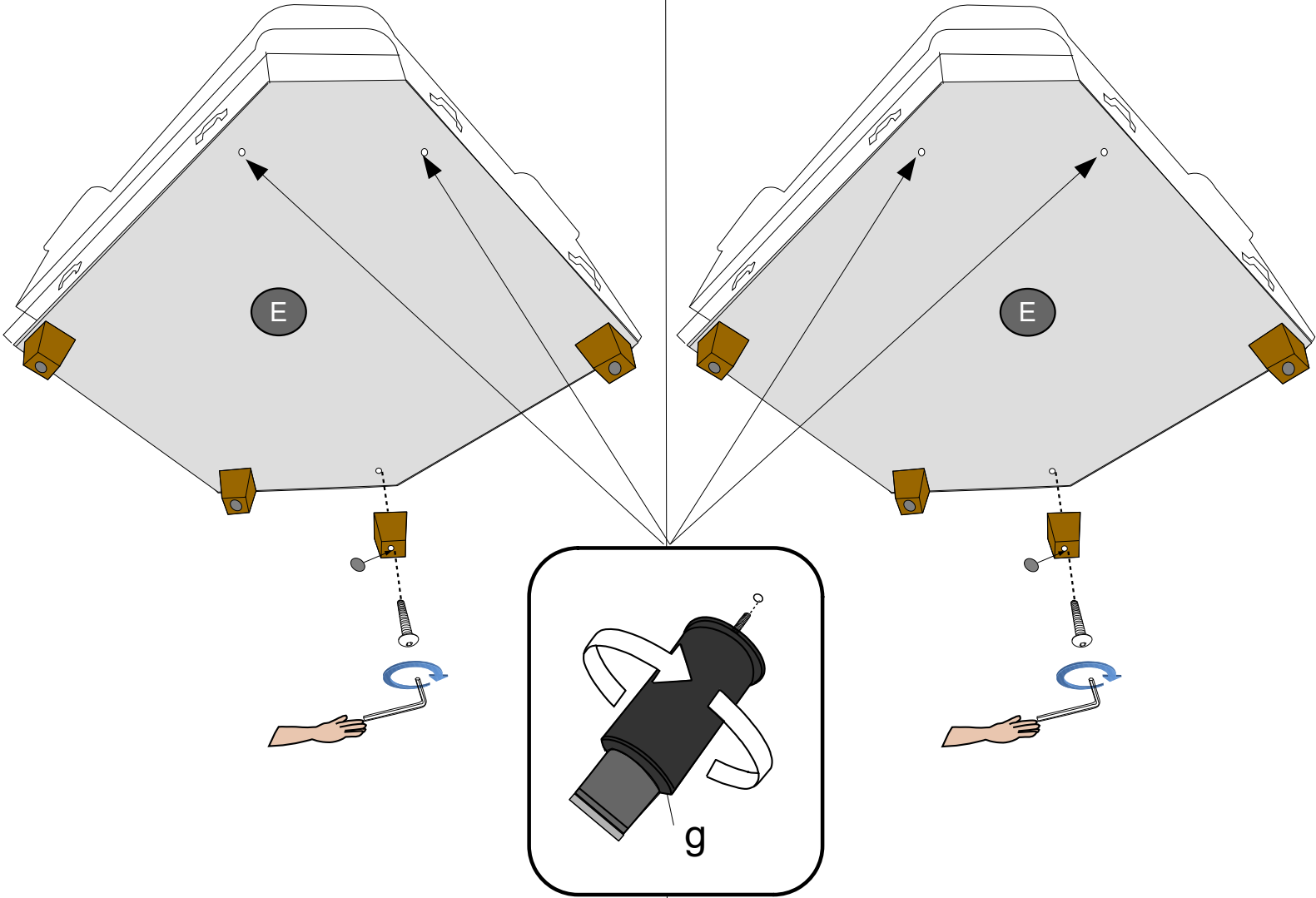





i L-5	f H-90	x Fi-50	q M8*80	g H(70-120)
				
X1	X4	X4	X4	X2

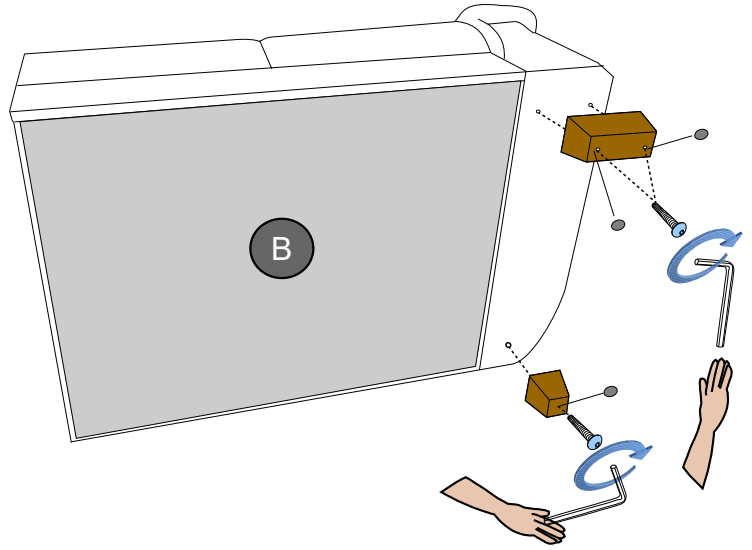
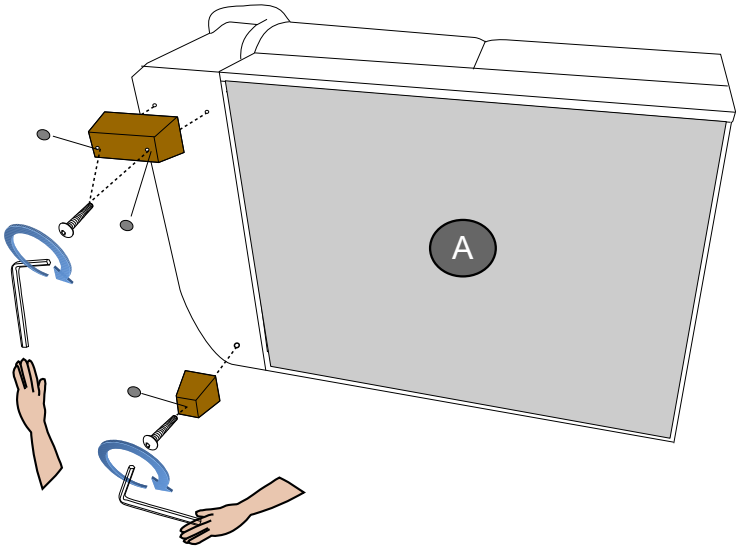

s H-90 	i L-5 	f H-90 	x Fi-50 	q M8*80 
X1	X1	X1	X3	X3



s H-90 	i L-5 	f H-90 	x Fi-50 	q M8*80 
X1	X1	X1	X3	X3

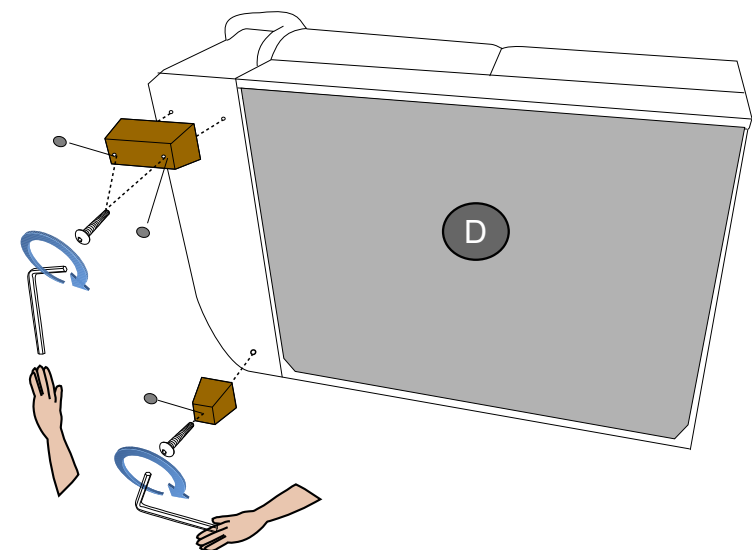
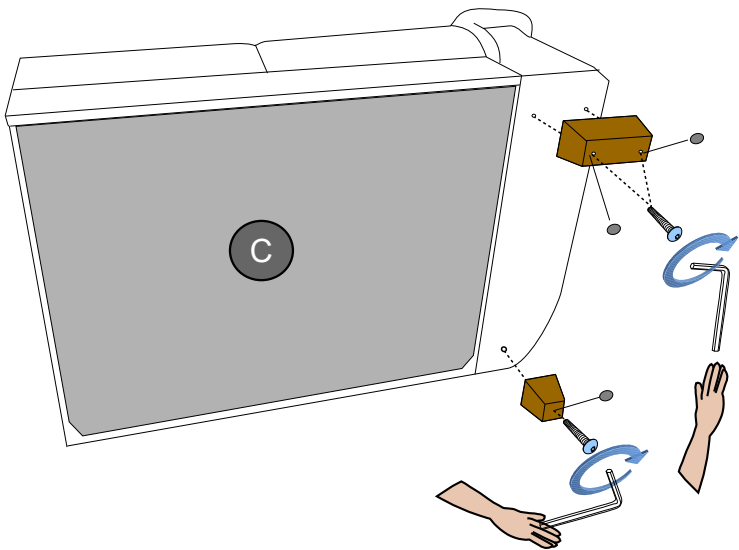

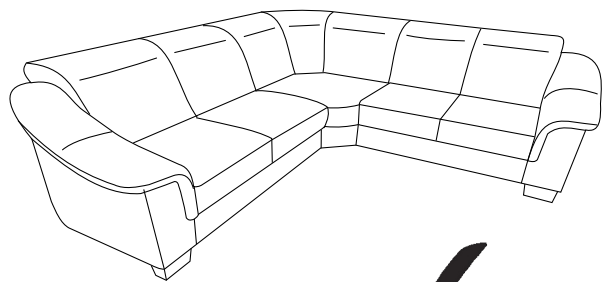
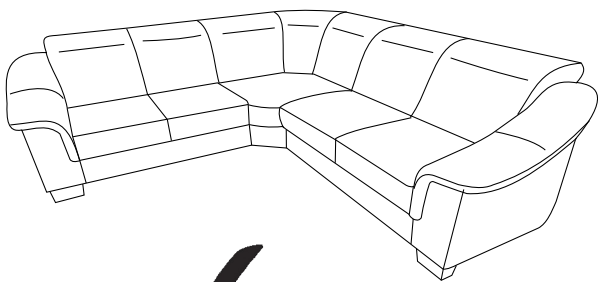
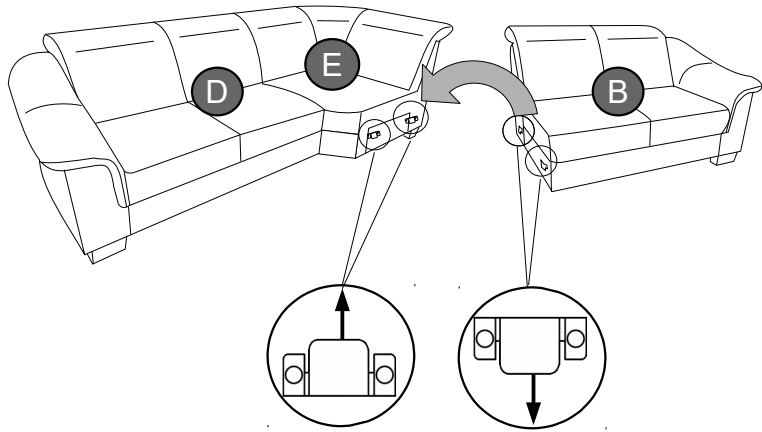
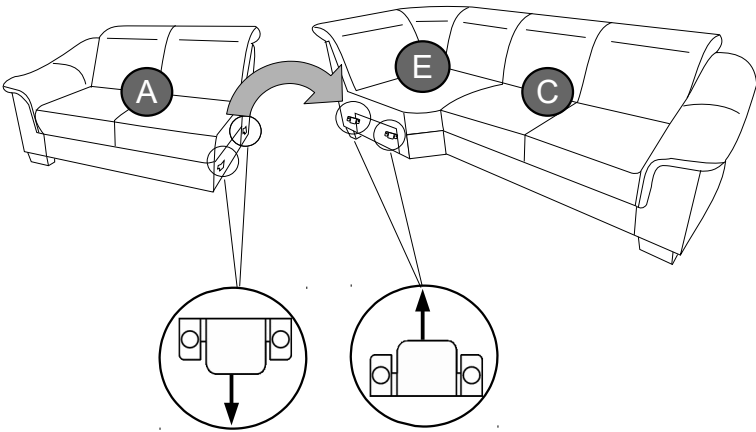
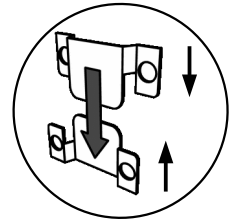
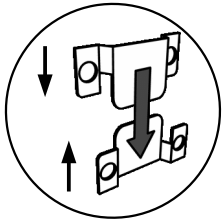
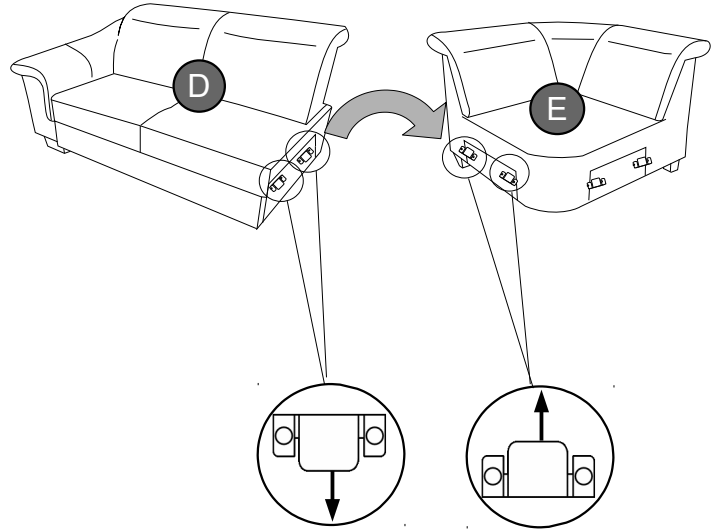
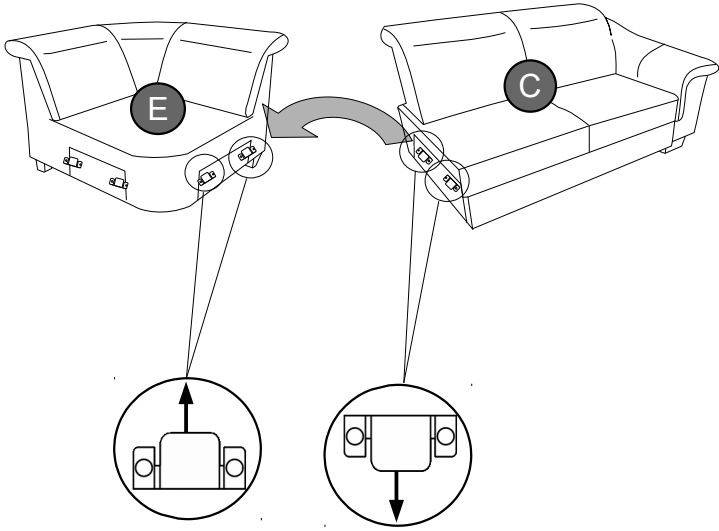
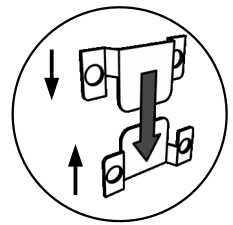
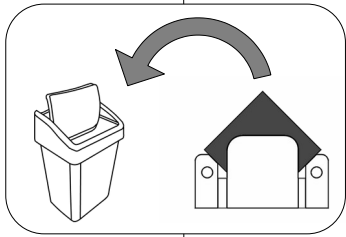
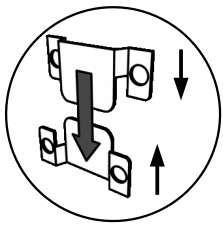

Service · Dienstverlening · Servis · Servis · Сервисная служба · Serviciu · Services · Servizio
 · Servisný list · Szolgáltatás · Servisní list

Name · Naam · Nazwa · Ísim · Название · Nume · Nome · Název · Názov ·
 Název · Neve

EMPIRE

Typ · Type · Tip · Тип · Tipo · Típus

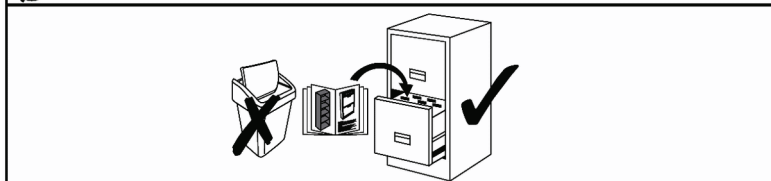
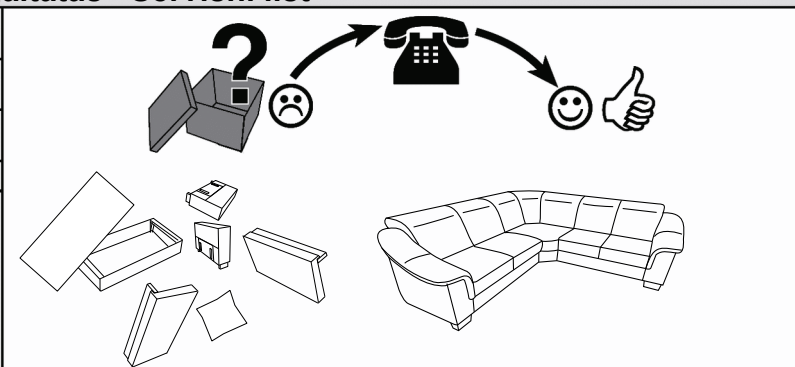

R

L

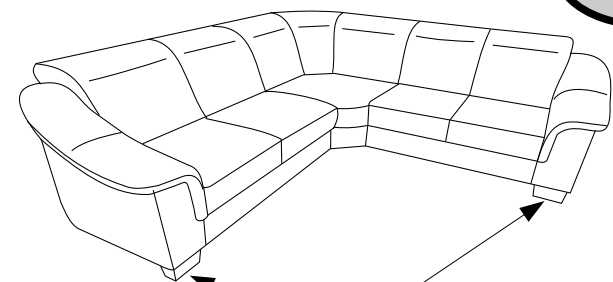
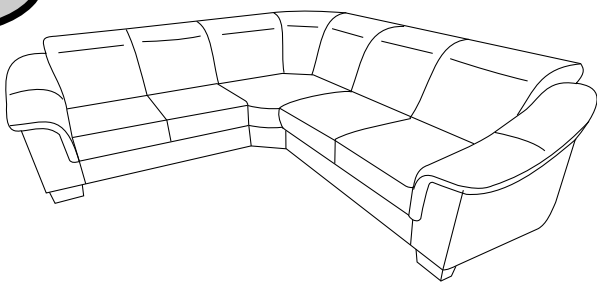

i L-5	f H-90	g H(70-120)	x Fi-50	q M8*80	s H-90 [mm]

