



F 563 Montageanleitung 6547 Datum 30.06.20

- (D) Montageanleitung
- (FR) Notice de montage
- (NL) Handleiding voor de montage
- (CZ) Montážní návod
- (HU) Szerelési útmutató
- (TR) Montaj talimatı

- (GB) Assembly instructions
- (IT) Istruzioni di montaggio
- (PL) Instrukcja montażu
- (SK) Návod na montáž
- (RO) Instrucțiuni de montaj
- (RU) Инструкция по монтажу

	4 x 3,5 x 16
Holzschraube	
	4 x 3,5 x 16
Blechschaube	
	4 x 60 mm

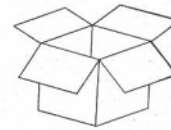
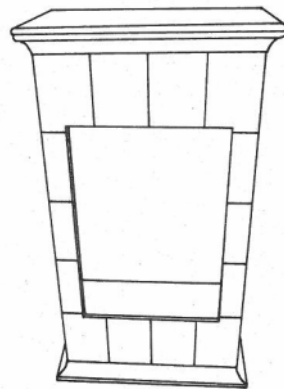
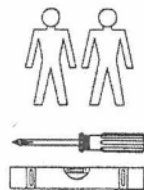

1

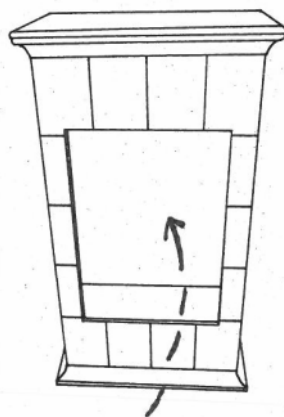
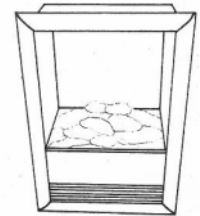

2

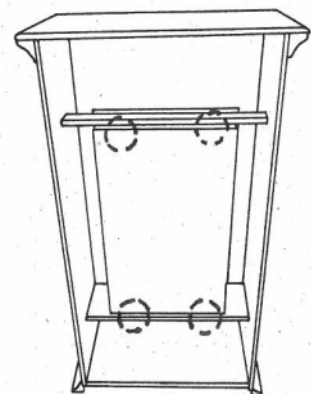
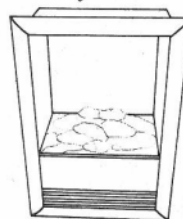

3

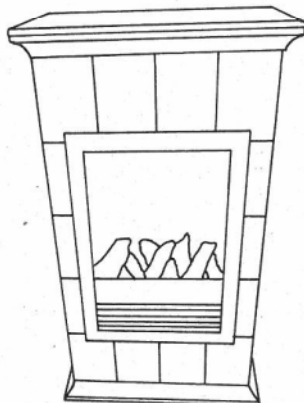
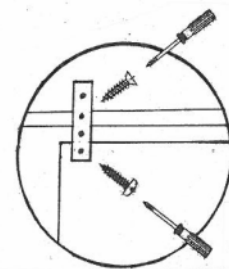

4

